



Open Hardware PowerPC Notebook

We really want to make it happen: a PowerPC notebook released as Open Source



LINUX
D A Y

27 October 2018

University of Bergamo

what
Open Hardware PowerPC Notebook

who & why
Who is "Power Progress Community"?

how
How are we going to achieve our goals?

when
When the laptop PCB is going to be ready?



1) An Open Hardware project

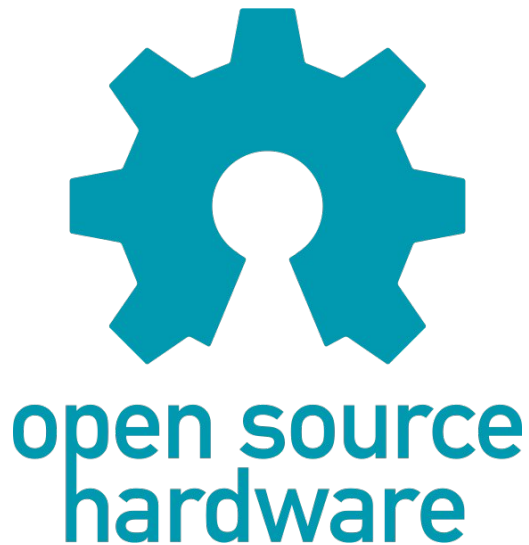

VS



OSH - Open-Source Hardware

Qualche volta anche indicato come

FOSH - Free and Open-Source Hardware

Chiaro riferimento al

FOSS - Free and Open-Source Software

Open-Design Movement and the **Maker Culture**

1) An Open Hardware project

Progetto **pubblico**,
tale che **chiunque** possa studiare,
modificare, distribuire, realizzare,
e **vendere** il progetto o l'hardware basato su di esso.

Alcune parti del progetto possono
non essere Open Source Hardware.

Si possono includere componenti di terze parti
protette da **NDA**, ma è importante che siano
esplicitamente indicate.

Open Source Hardware Certification

<https://www.oshwa.org>



Cosa?!?

Il PowerPC esiste ancora nel 2018?



La CPU è stata progettata nel 1991 (l'x86 nel 1978).

Il PowerPC era progettato già a 64bit.

Popolare nei desktop e console nei due decenni 1990 e 2000

(Apple Power Mac, Playstation, Xbox, Nintendo)

Ottimo bilanciamento consumo/prestazioni.

Oggi utilizzato per prodotti embedded e server (IBM Power).

2) A project to revive the Power(PC) architecture

Schede madri di recente progettazione

Con CPU IBM Power 9

Con CPU NXP QorIQ



RAPTOR
COMPUTING SYSTEMS
TALOS II

<https://www.raptorcs.com/TALOSII>



A-EON
TECHNOLOGY

<http://www.a-eon.com/>



OpenPOWER™

<https://openpowerfoundation.org/>



<https://www.powerprogress.org/>
<https://www.powerpc-notebook.org/>

Linux Day, 27 October 2018
University of Bergamo

3) A project that will deliver all data to make a laptop

Un progetto di un laptop con queste caratteristiche

CPU	NXP T208x, e6500 64-bit PowerPC with AltiVec 4 x e6500 dual-threaded, 2MB L2, 16GFLOPS x core
RAM	2 x RAM slots for DDR3L SO-DIMM
VIDEO	MXM Radeon HD Video Card (removable)
AUDIO	Sound chip, audio in and audio out jacks
USB	3.0 and 2.0
STORAGE	NVM Express (NVMe), M.2 2280 connector 2 x SATA 1 x SDHC card reader
NETWORK	Ethernet RJ-45 connector WiFi connectivity Bluetooth connectivity
POWER	On-board battery charger and power-management
CHASSIS	Standard notebook case 15,6"

3) A project that will deliver all data to make a laptop

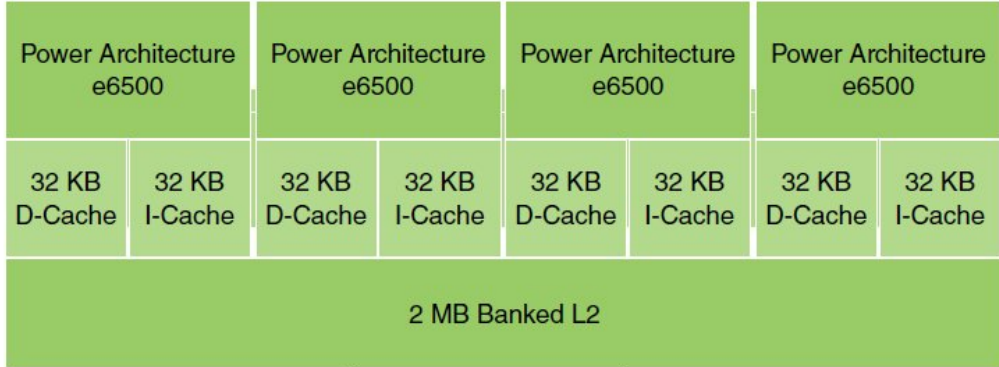

CPU NXP T2080
 4 core fisici e6500 PPC 64-bit con Altivec dual-threaded (8 core logici)
 2MB Level 2 cache, 16GFLOPS per core

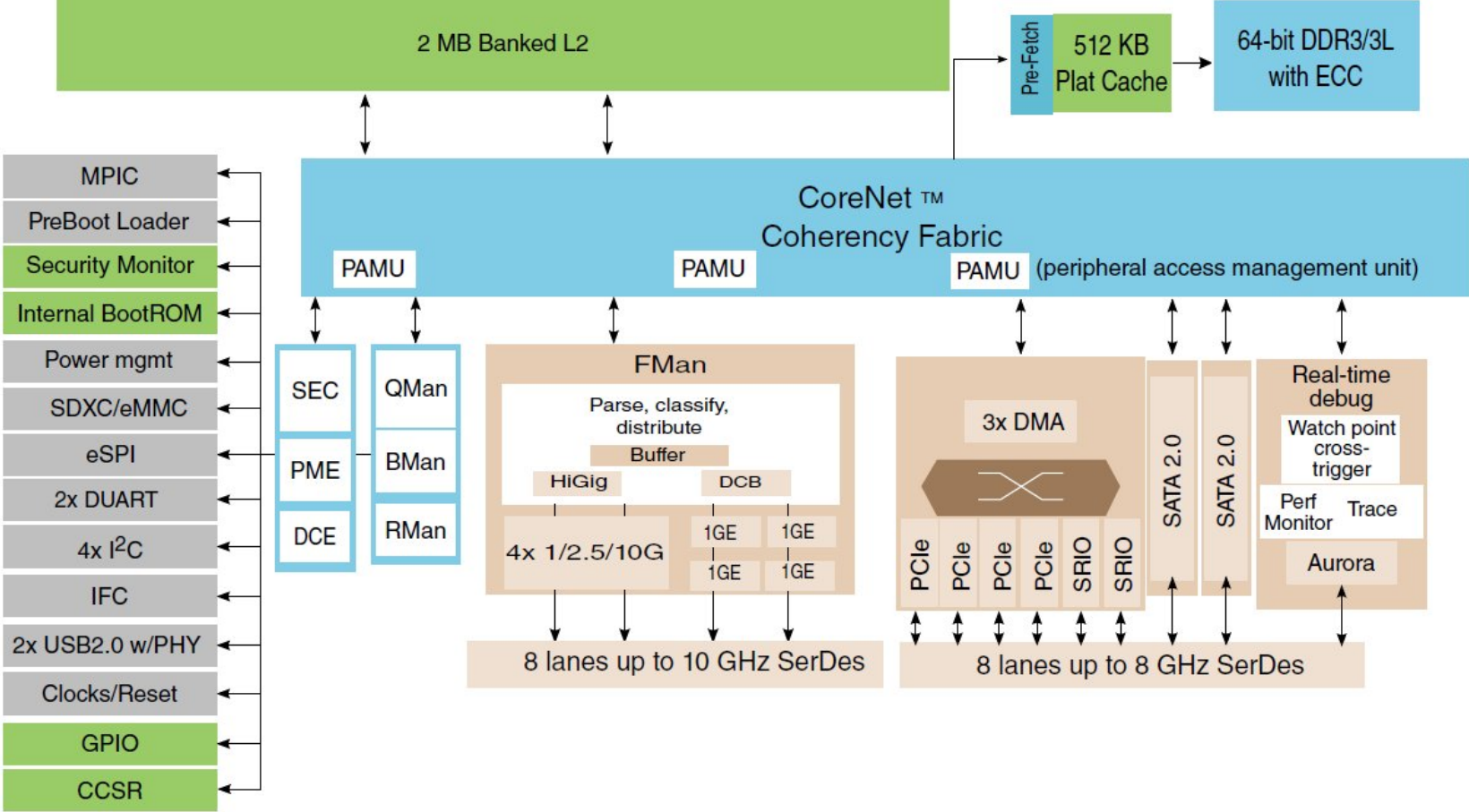

3) A project that will deliver all data to make a laptop

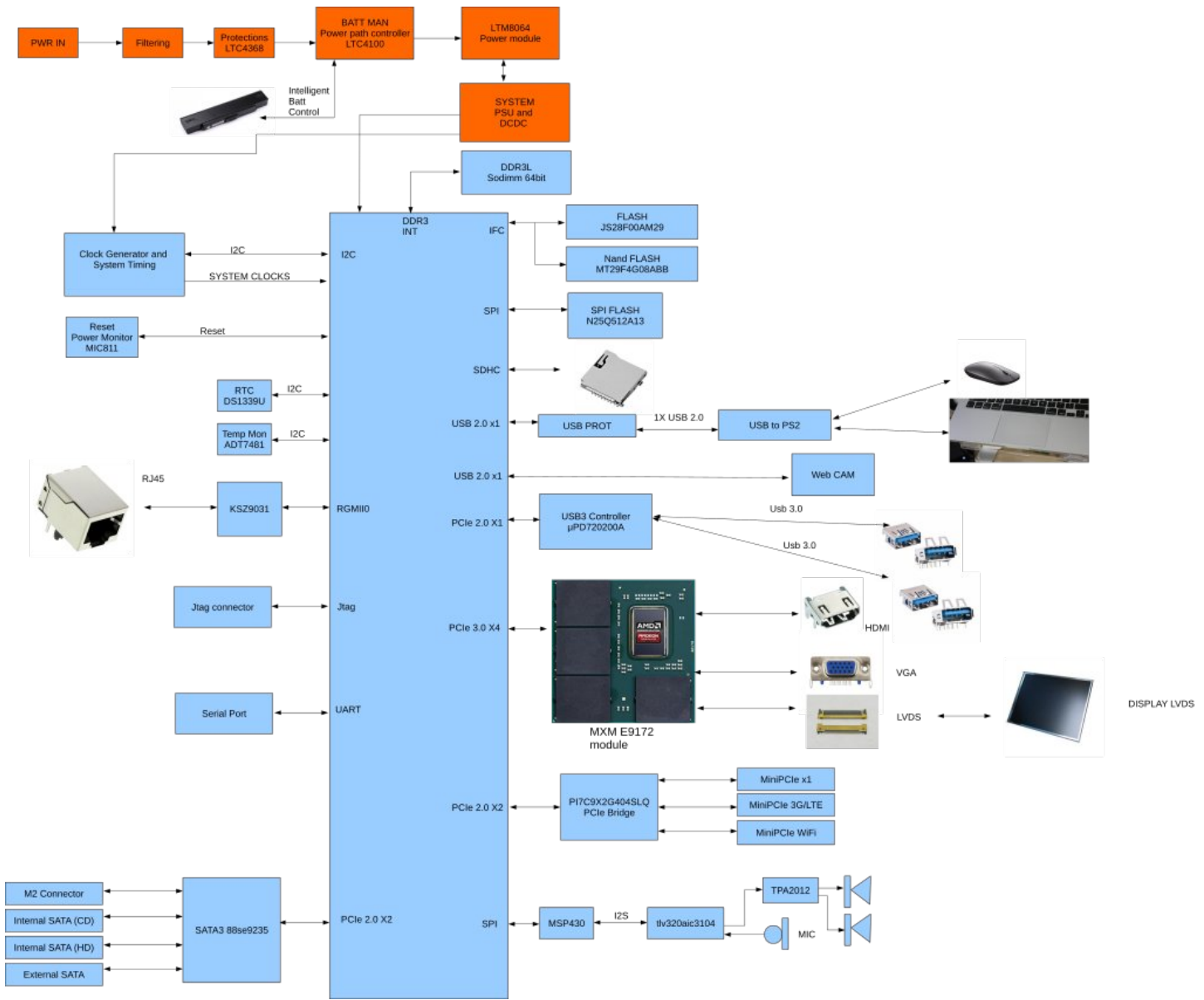

Chi siamo

- Associazione **Power Progress Community**
(*no profit, fondata a Milano nel 2016*)
- Comunità di appassionati (volontari) che si occupano di dare forza al Free Software e all'Open Hardware, che amano hardware ed architetture indie-pendenti
- Gruppo di acquisto solidale tecnologico
- Promuoviamo relazioni positive ed umane tra i partecipanti
- Ci interessa la collaborazione
- La libertà di Scelta

Cosa vogliamo

- Fare ricerca e sviluppo
- Decidere sul nostro hardware
- Decidere sul nostro software

Chi NON siamo

- Non siamo un'azienda
- Non vendiamo prodotti
- Non ci interessa il profitto
- Non ci interessa il mercato
- Non ci interessa essere competitivi

Cosa NON vogliamo

- Non vogliamo fare *crowdfunding*
- Non vogliamo fare gli imprenditori
- Non vogliamo fare una startup

Who & Why

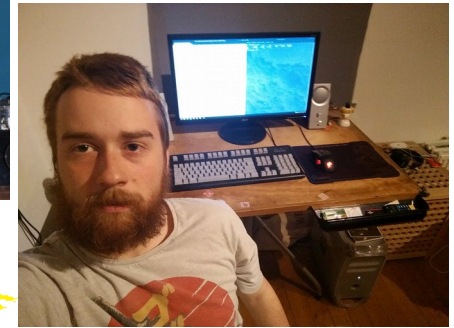
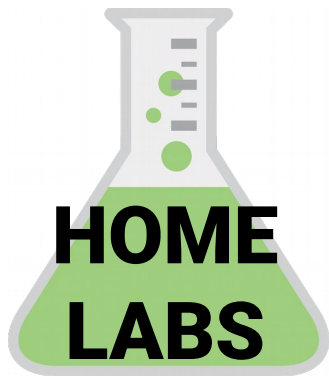

**partecipanti
da tutto il
mondo**



**alcuni componenti
del gruppo italiano**

concentrati su
piattaforma
PowerPC 64bit
(PPC64)
al momento si
sviluppa su
Mac G5

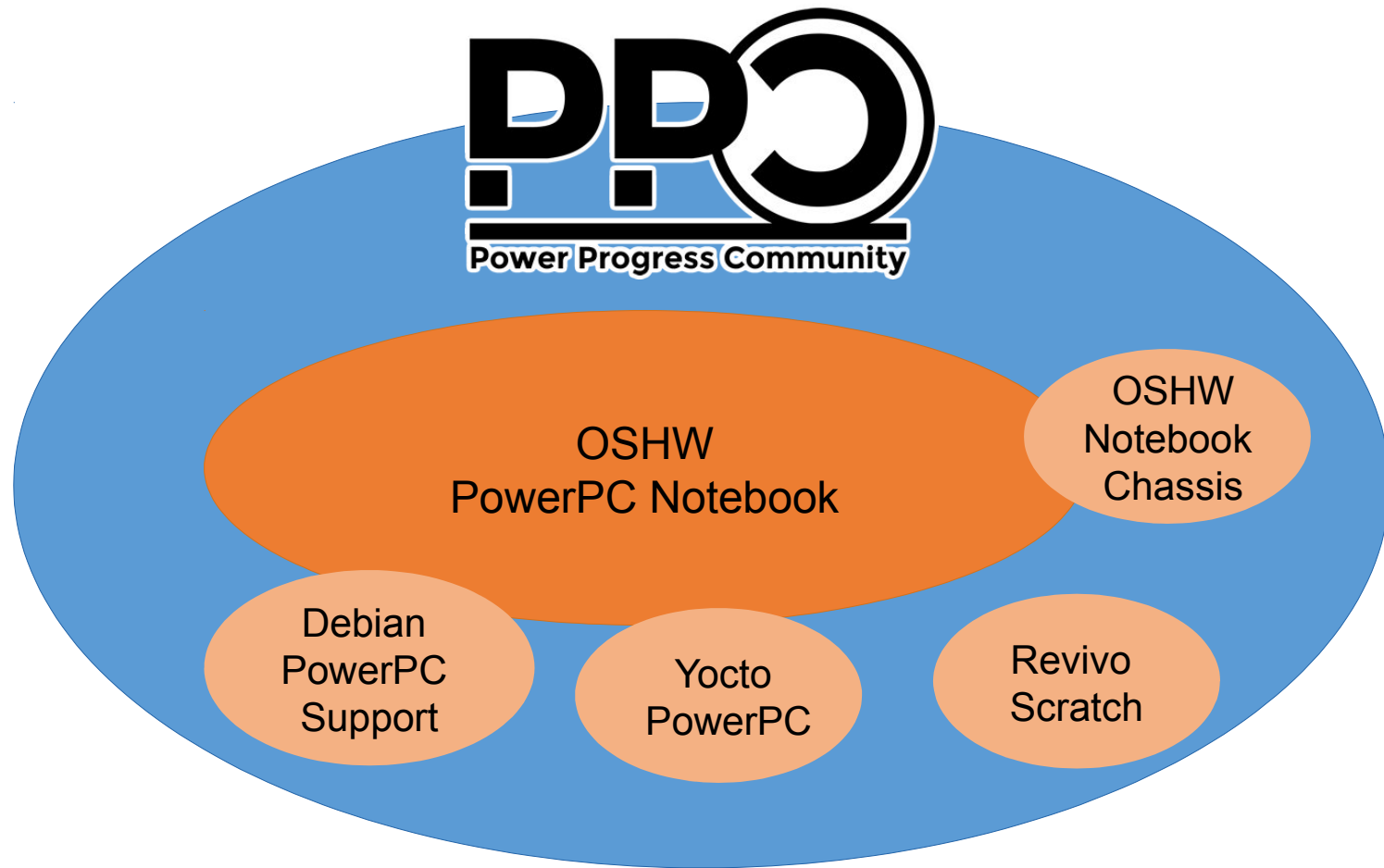

Attualmente la quota annuale di iscrizione è di € 30 (€ 10 per studenti).

Associandosi si supportano i vari siti web, stampe pubblicitarie e l'acquisto di componentistica per testare i vari elementi del laptop

<https://www.powerprogress.org/>

Attività

Campagna di donazioni

- Gestione della piattaforma di donazioni, gestione conto bancario e PayPal

Comunicazione

- Sito web dell'associazione e del progetto del laptop
- Forum web, mailing list, email, questionari d'indagine e newsletter
- Social media (e.g. twitter, facebook, YouTube)
- Partecipazione ad eventi (e.g. Linux Day, incontri, esposizioni)
- Relazioni con altri gruppi di volontari e società private

Gruppi interessati alle parti hardware

- Scheda madre
- Scocca del portatile (chassis)

Gruppi interessati alle parti software

- u-boot bootloader
- Linux kernel per PPC64
- Linux distros per PPC64 (e.g. Debian, Yocto)
- Port di vari software su PPC64 con Altivec

Campagne di donazioni

Fasi previste



1	Schemi elettrici Iniziata il 2 luglio 2017, conclusa il 7 giugno 2018, risultati in corso di pubblicazione	€ 12.600
2	PCB Printed Circuit Board gerber file degli schemi elettrici	€ 11.950
3	Realizzazione di 5 prototipi	€ 8.800
4	Test approfondito dell'hardware	€14.400
5	Certificazioni CE	€ 12.500

Campagne di donazioni

Prima fase conclusa: schemi elettrici

- presto disponibili online -

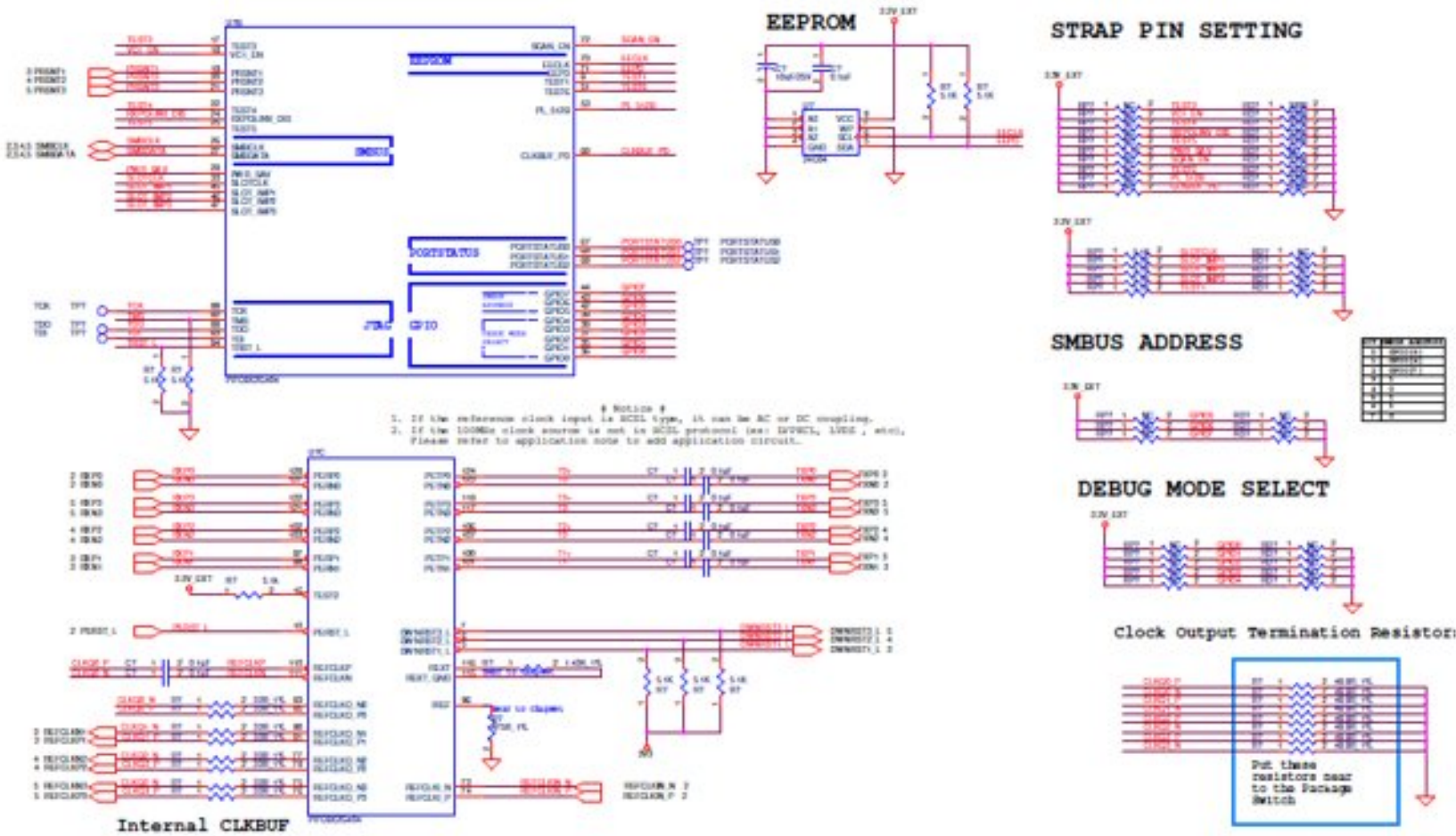

Campagne di donazioni

Prima fase conclusa: schemi elettrici

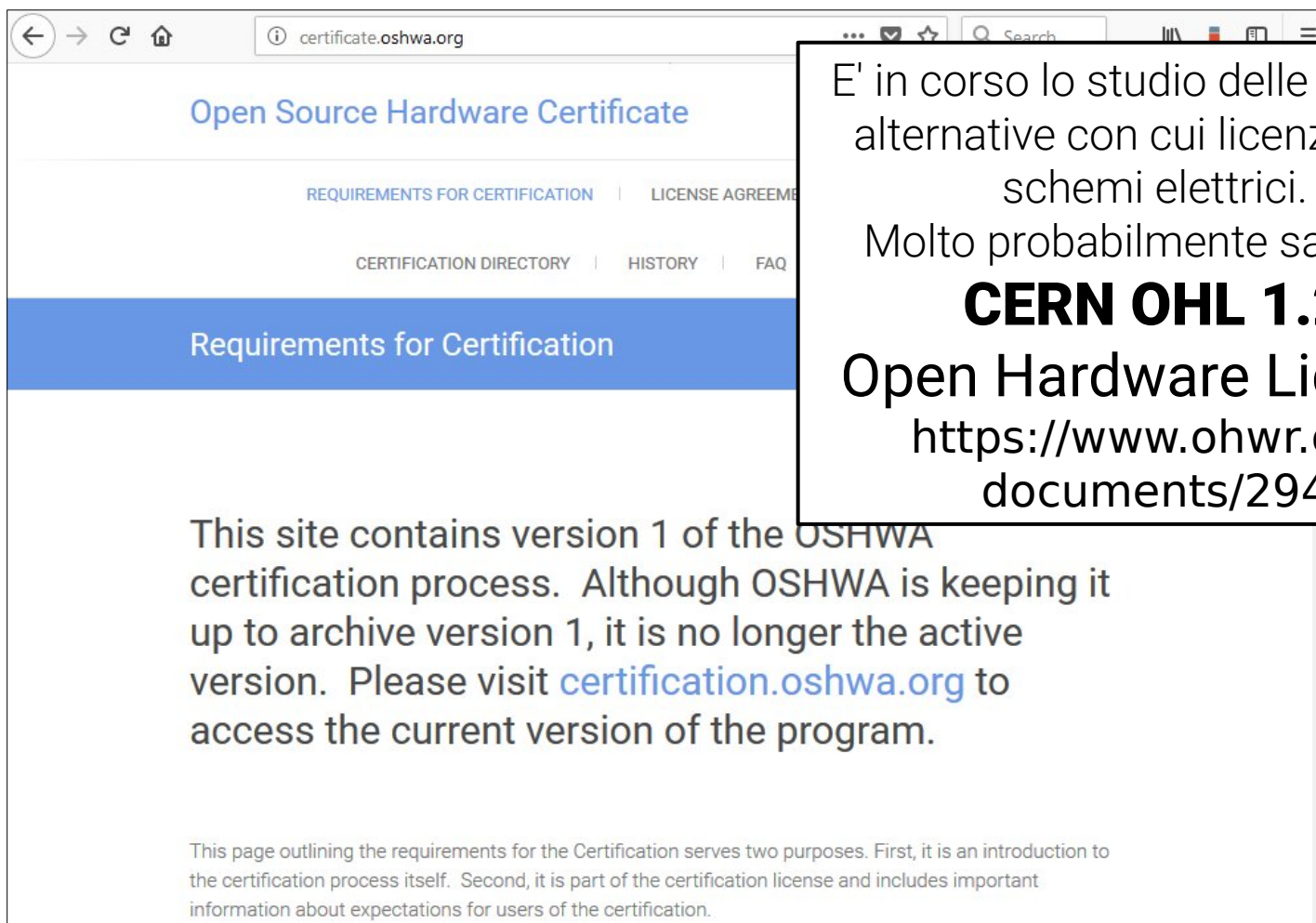

The screenshot shows a web browser window with the URL certificate.oshwa.org. The page title is "Open Source Hardware Certificate". The main content area is titled "Requirements for Certification" and contains the following text:

This site contains version 1 of the OSHWA certification process. Although OSHWA is keeping it up to archive version 1, it is no longer the active version. Please visit [certification.oshwa.org](https://www.oshwa.org/certification) to access the current version of the program.

Below this text, there is a smaller paragraph: "This page outlining the requirements for the Certification serves two purposes. First, it is an introduction to the certification process itself. Second, it is part of the certification license and includes important information about expectations for users of the certification."

E' in corso lo studio delle possibili alternative con cui licenziare gli schemi elettrici.

Molto probabilmente sarà una

CERN OHL 1.2

Open Hardware Licence

<https://www.ohwr.org/documents/294>

Campagne di donazioni

Prima fase conclusa: schemi elettrici

www.law.nyu.edu/academics/clinics/semester/technolog...

SUPPORT NYU LAW QUICKLINKS

NYU | LAW

JD Admissions Faculty
LLM/JSD Admissions Academic
Executive Programs Current
About NYU Law Alumni

Home > Academics > Clinics > One-Semester Clinics > Technology Law and Policy

ONE-SEMESTER CLINICS

Brennan Center Public Policy Advocacy Clinic
Business Law Transactions Clinic
Civil Litigation - Employment Law Clinic
Civil Rights: Challenging Mass Incarceration
Comparative Criminal Justice Clinic
Criminal Appellate Defender Clinic
Criminal Justice Reform and the District Attorney Externship

CLINICS

Technology Law and Policy Clinic

LW.12148 / LW.12149
Professor Jason Schultz
Professor Brett Max Kaufman
Amanda Levendowski, Teaching Fellow and Supervising Attorney
Open to 2L and 3L students
Maximum of 12 students

Fall semester
6 credits*
Pre-requisites/Co-requisites: None, but courses in privacy, intellectual property, or First and Fourth Amendment law will prove useful.

Introduction

Technological advances are driving greater social, economic, and political change—from access to information, health care, and entertainment to increased surveillance by law enforcement agencies to impacts on the environment, education, and commerce. These advances, however, raise increasingly critical and complex questions about privacy, consumer rights, free speech, and intellectual property are becoming increasingly critical and complex.

Per la parte legale stiamo collaborando con alcuni dottorandi che studiano alla New York University

Campagne di donazioni

Che succede se una delle fasi non va a buon fine?

L'associazione sottostà alle leggi italiane, per cui le donazioni sono libere e non rimborsabili.

Se entro tempi ragionevoli una delle campagne di donazioni non si dovesse concludere con successo si condurrà un'indagine con i donatori per decidere su quale delle attività condotte dall'associazione deviare i fondi raccolti.

Hardware Chassis

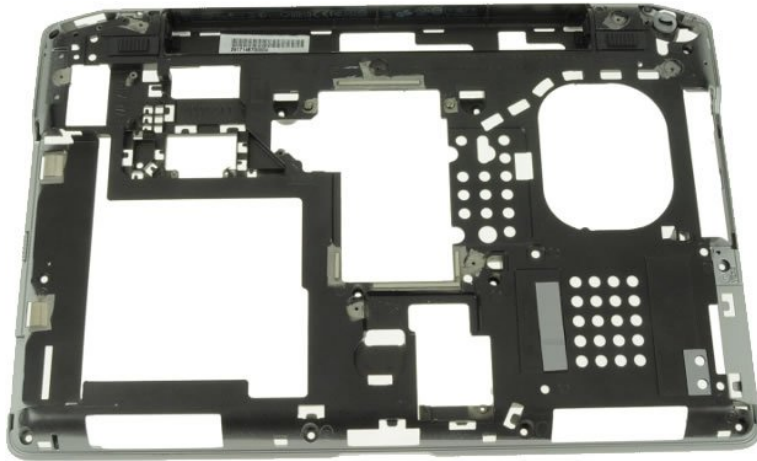

E' una sfida ancora in corso

Al momento abbiamo una soluzione temporanea riusando componenti di prodotti commerciali in produzione



Si sta tentando la via della progettazione ex-novo di un chassis che non cambi ogni 6 mesi

Hardware

NXP T2080rdb Development kit

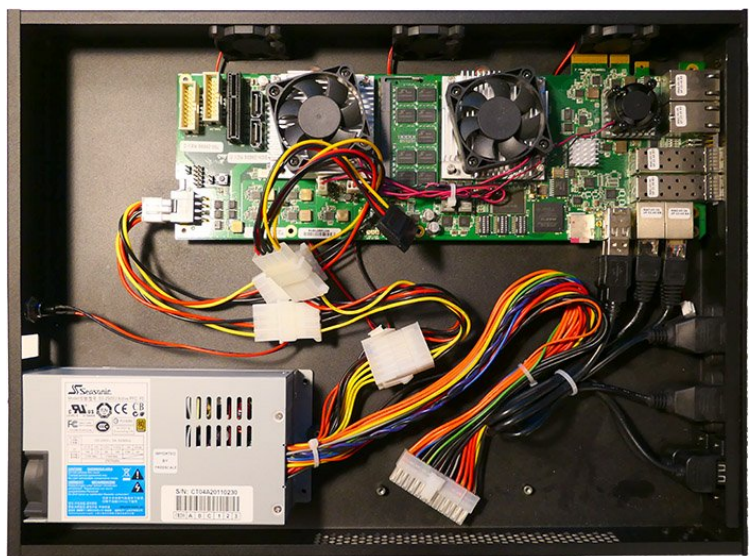

ETH4
ETH5
2 x USB 2.0
SD card

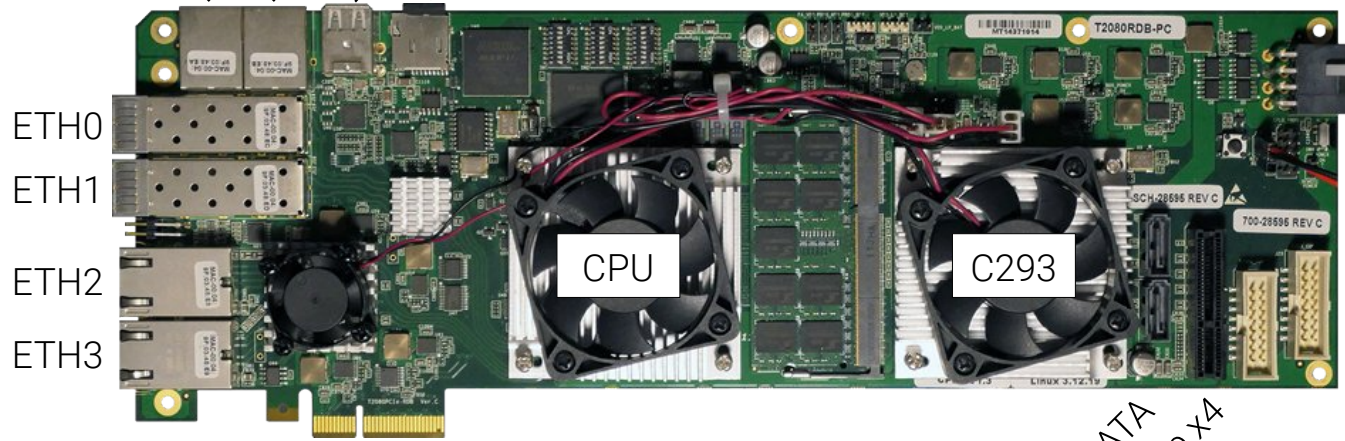

Power

PCIe x4

2 x SATA
PCIe x4

Hardware

NXP T2080rdb Development kit



ETH4
ETH5
2 x USB 2.0
SD card

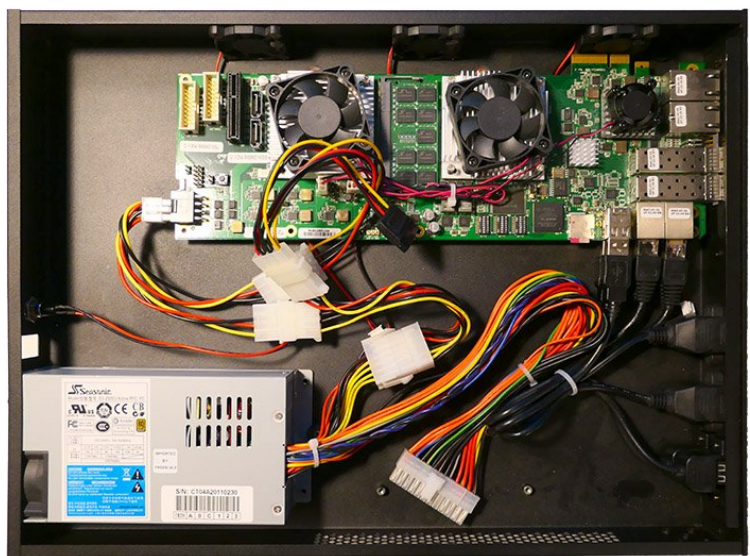

Power

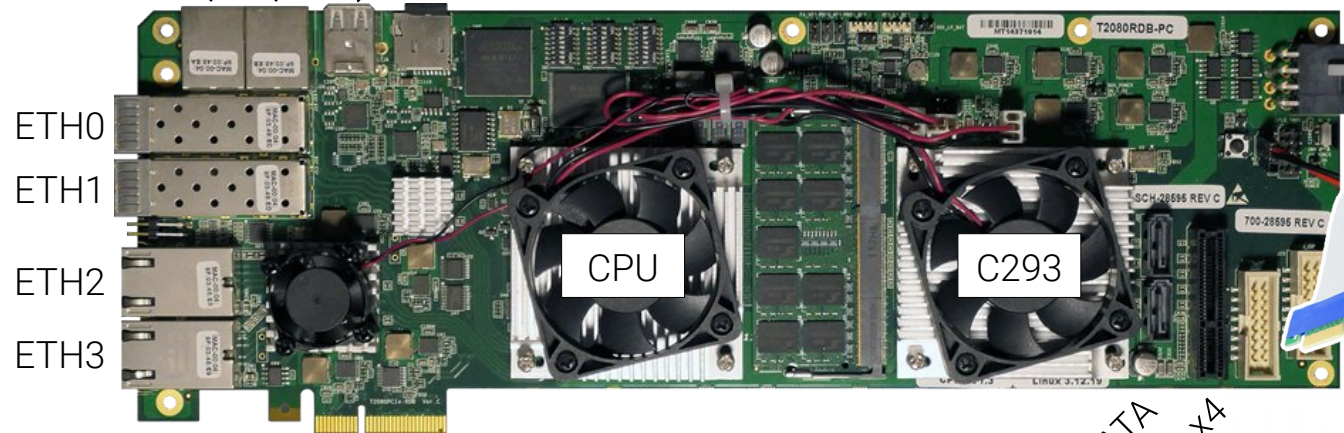

ETH0
ETH1
ETH2
ETH3

PCIe x4

2 x SATA
PCIe x4

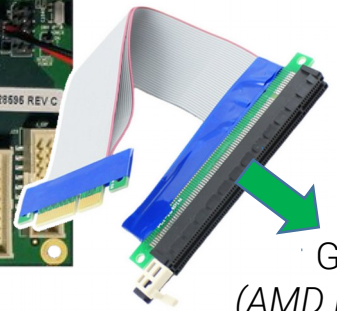

GPU
(AMD Radeon)



Hardware NXP T2080rdb Development kit

Realizzazione di un case in legno per usare il devkit

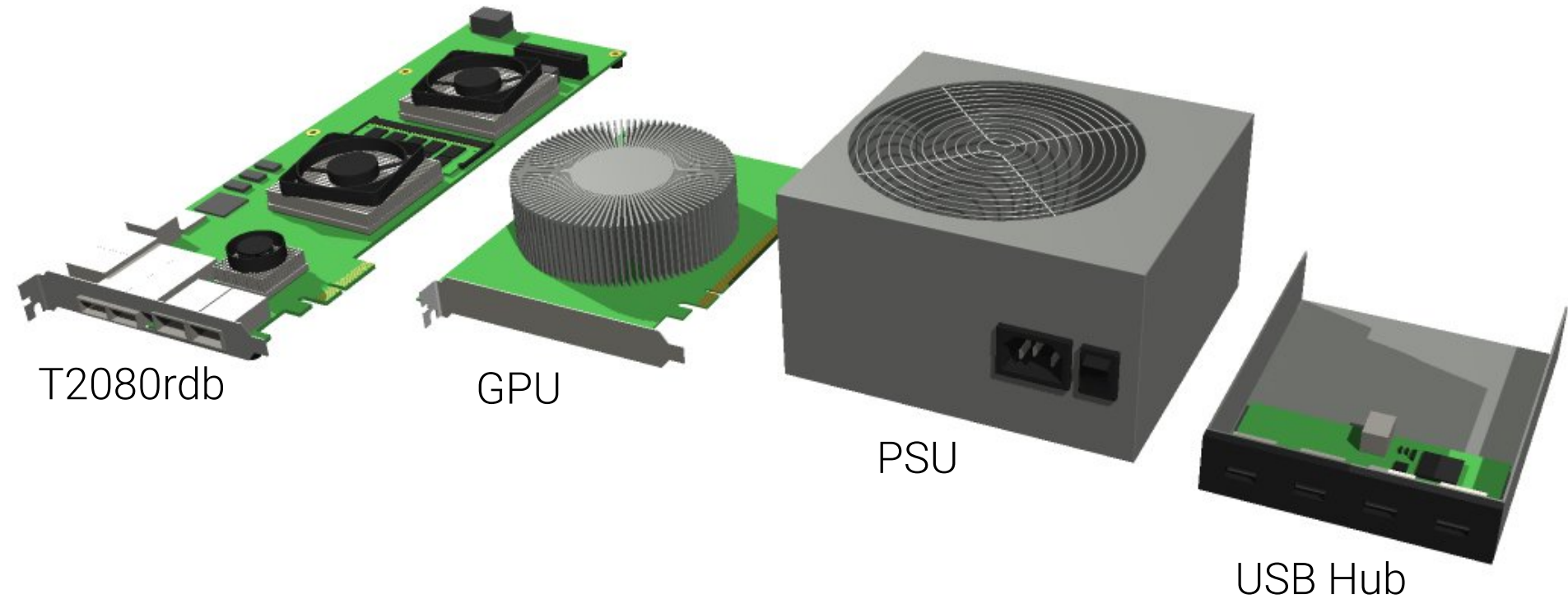

Hardware NXP T2080rdb Development kit

Realizzazione di un case in legno per usare il devkit

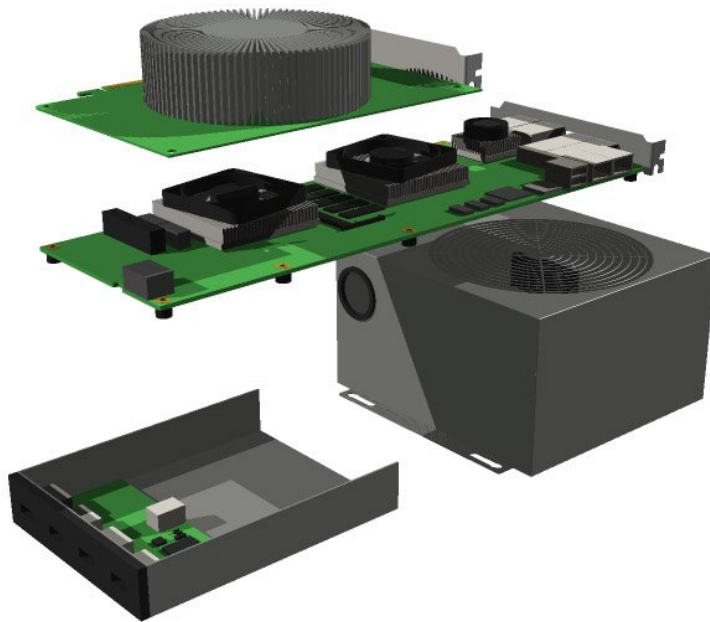

fronte

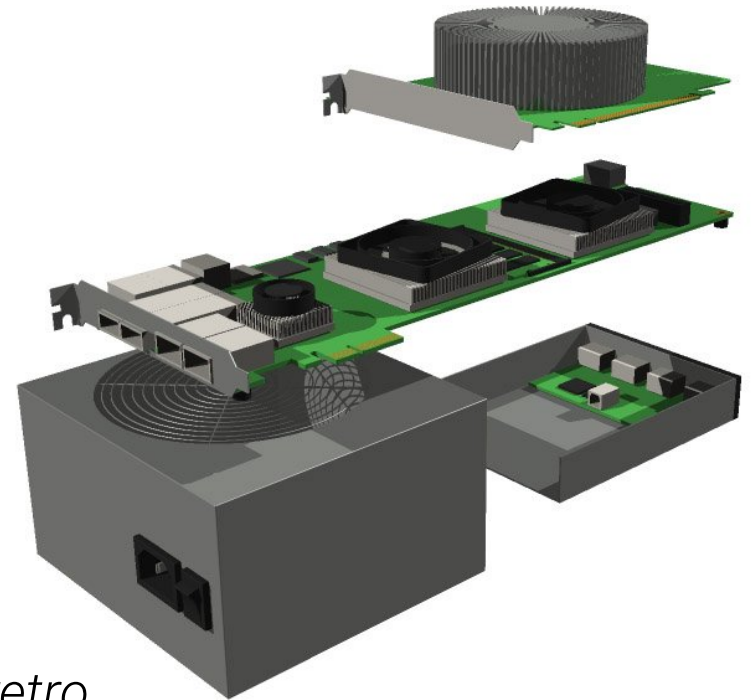

retro

Hardware NXP T2080rdb Development kit

Realizzazione di un case in legno per usare il devkit

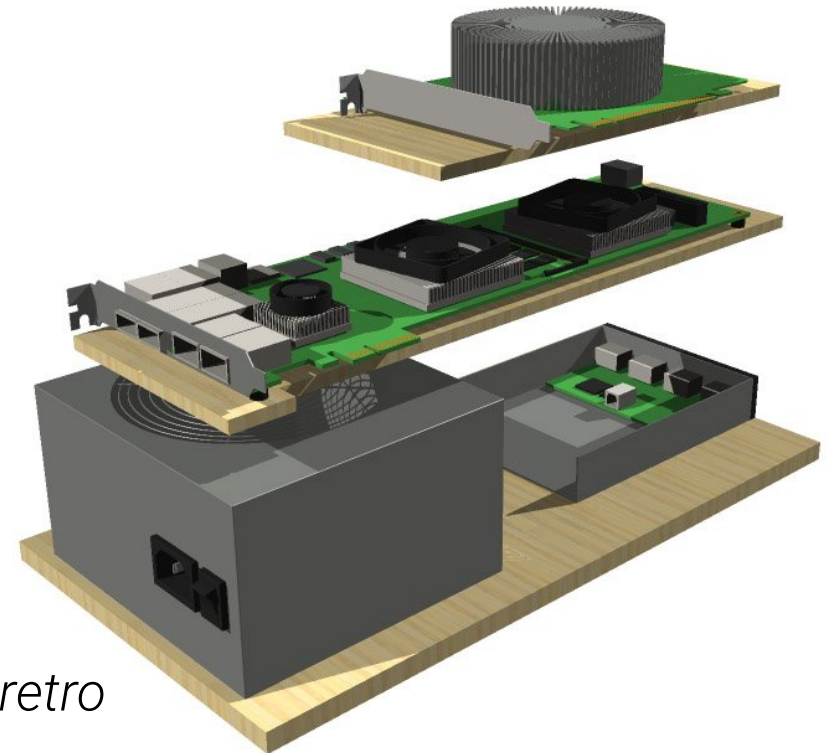
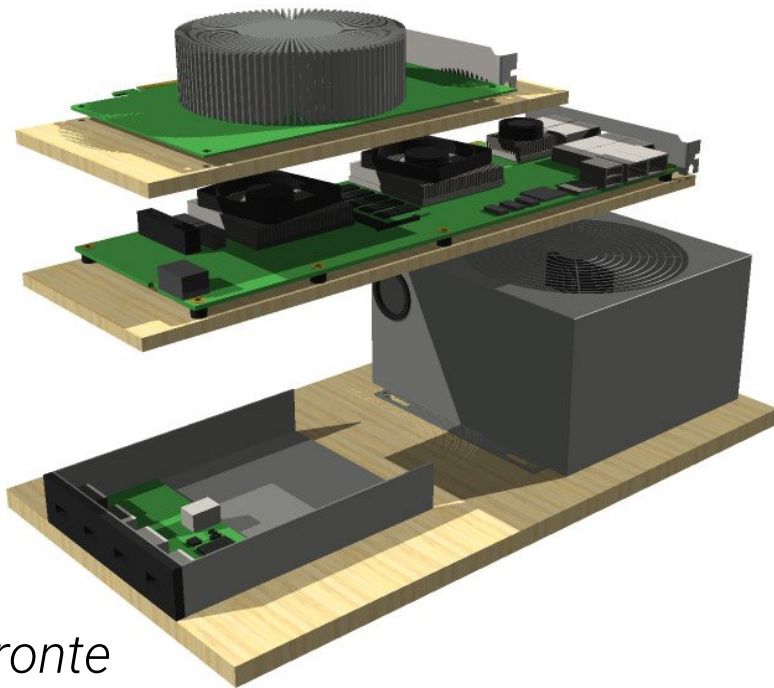

Hardware NXP T2080rdb Development kit

Realizzazione di un case in legno per usare il devkit

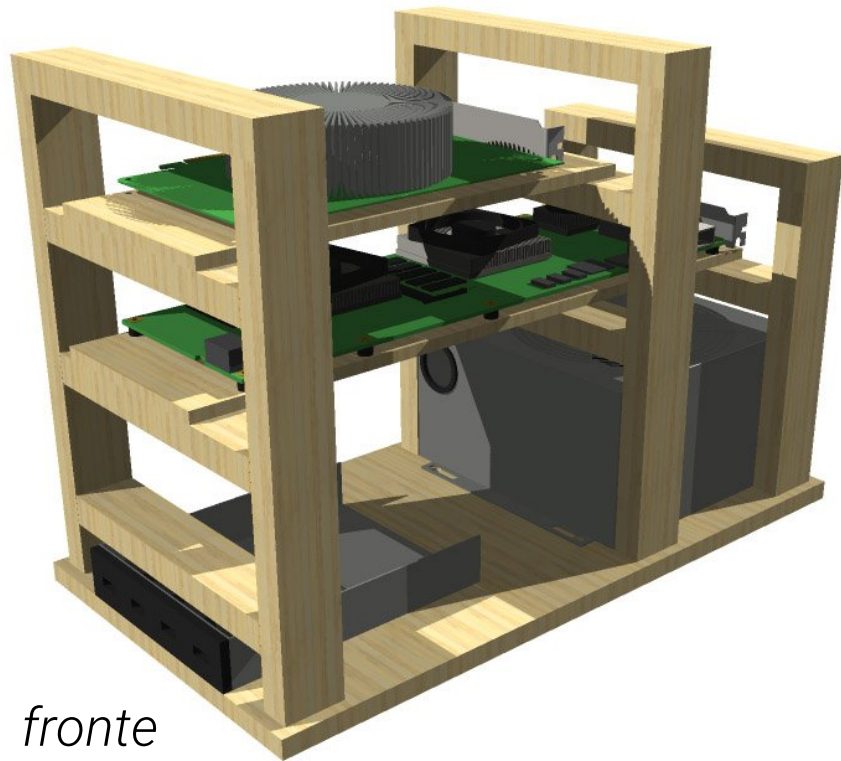

fronte

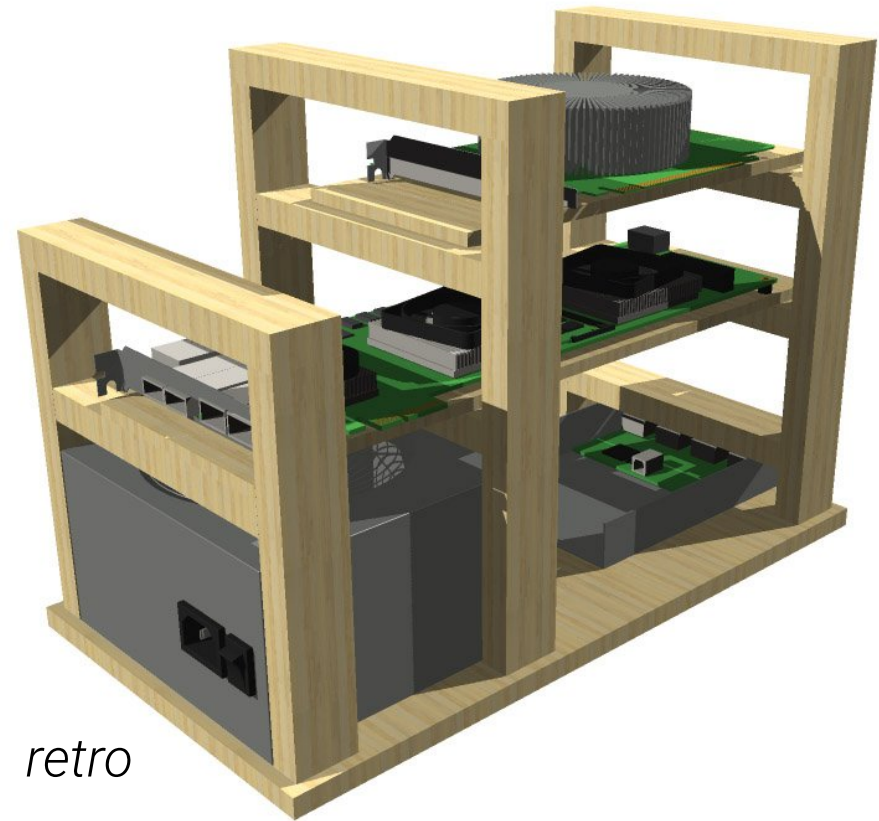

retro

Hardware NXP T2080rdb Development kit

Realizzazione di un case in legno per usare il devkit

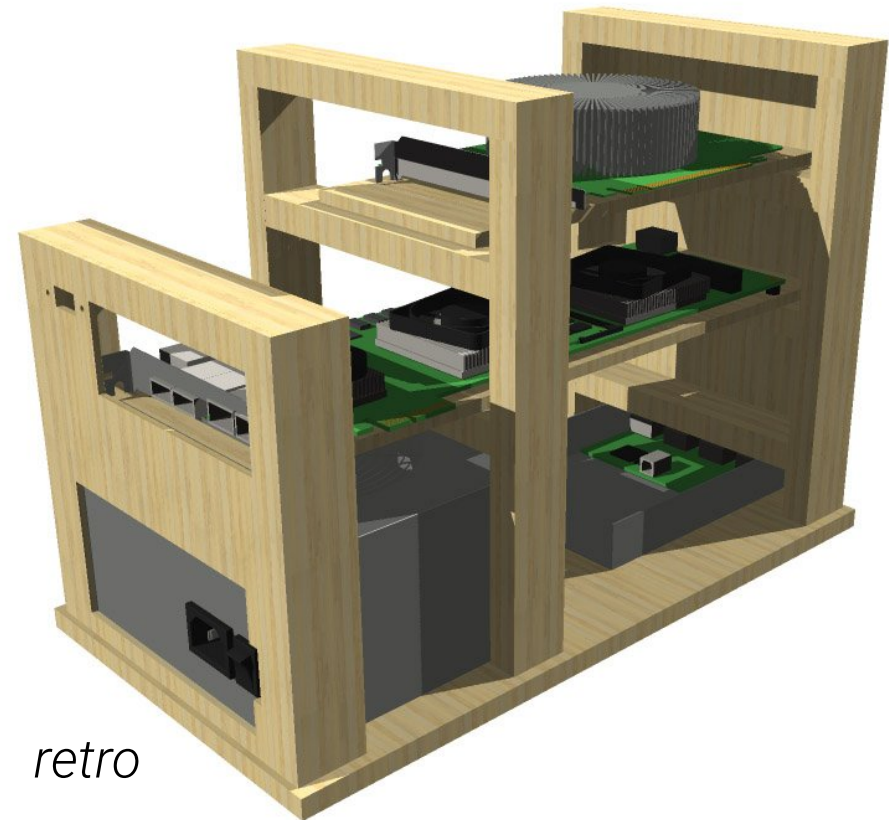
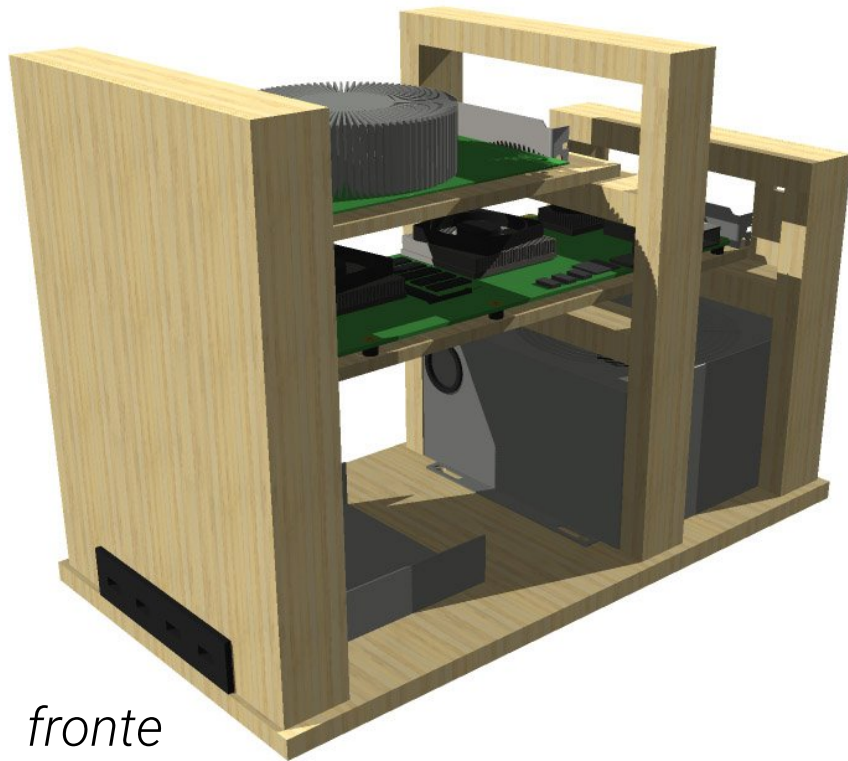

Hardware NXP T2080rdb Development kit

Realizzazione di un case in legno per usare il devkit

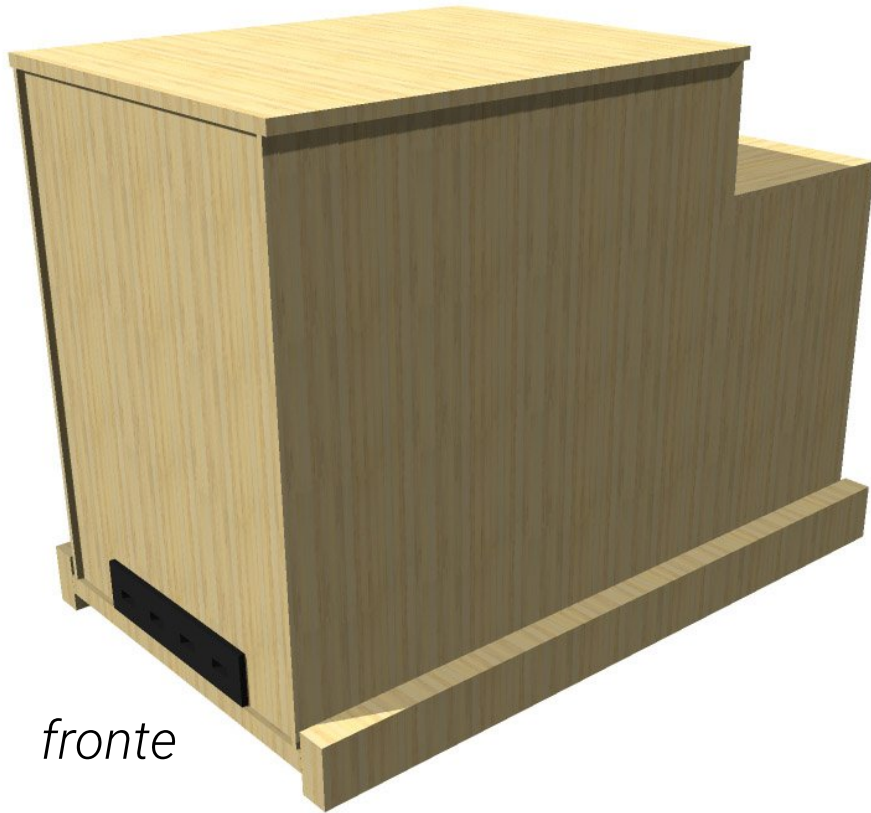

fronte



retro

Hardware NXP T2080rdb Development kit

Realizzazione di un case in legno per usare il devkit

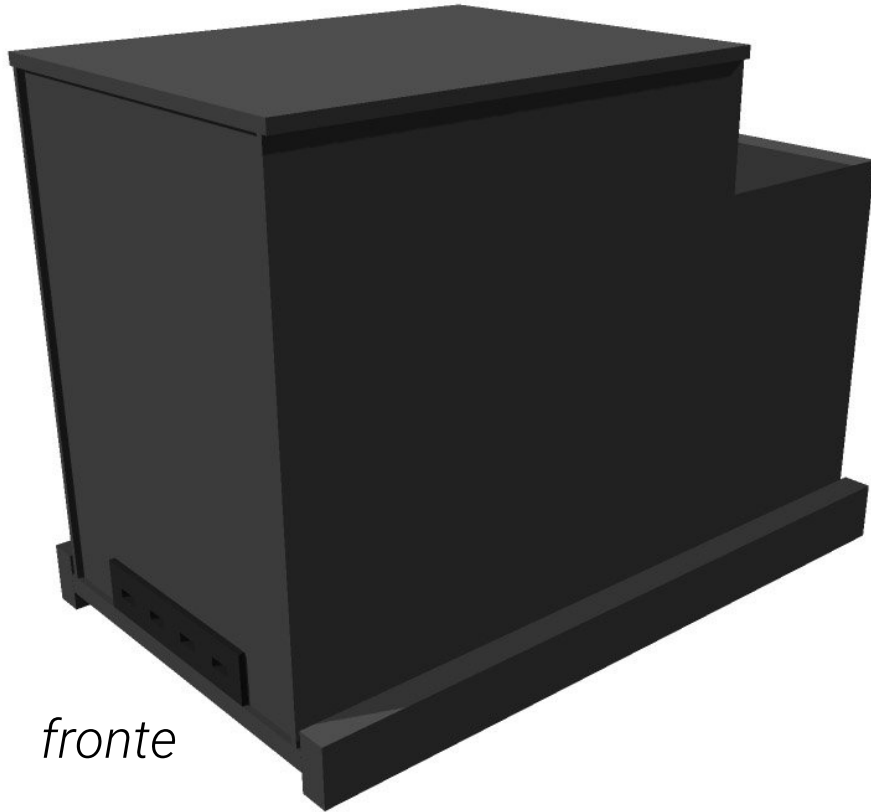

fronte

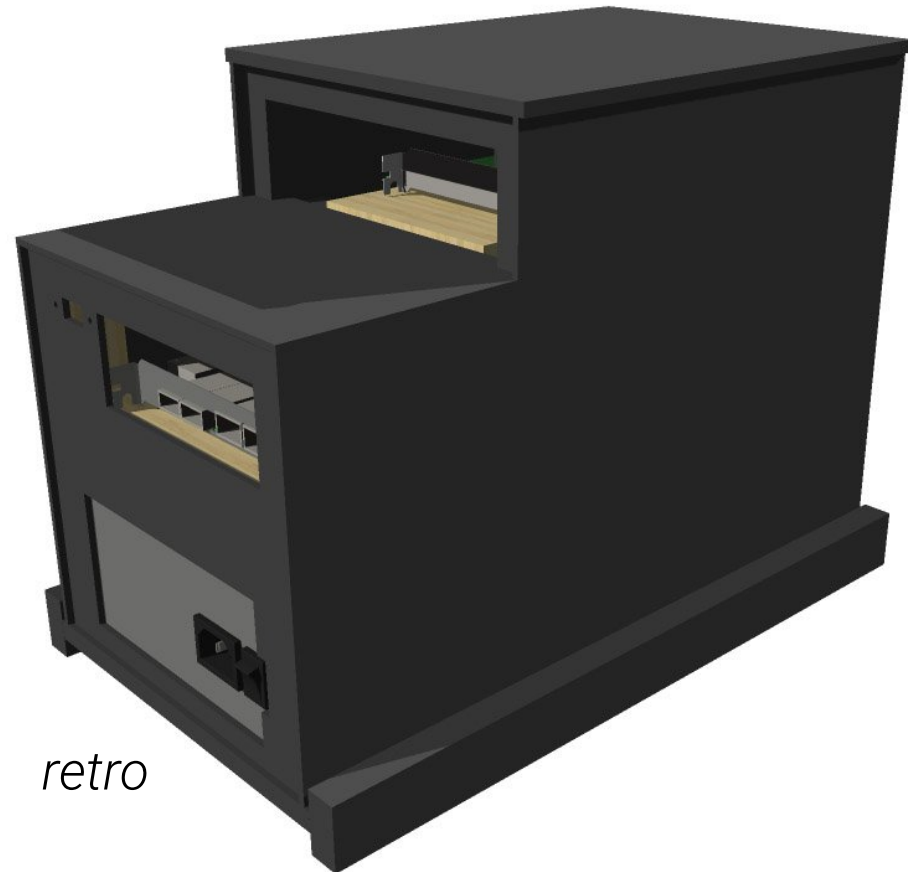

retro

Hardware NXP T2080rdb Development kit

Realizzazione di un case in legno per usare il devkit

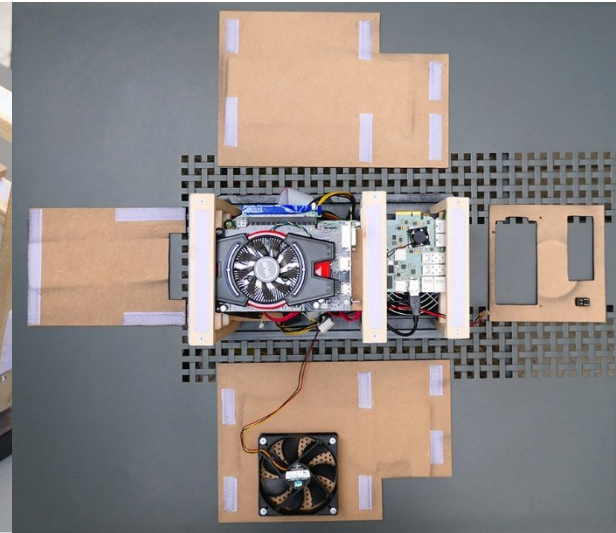
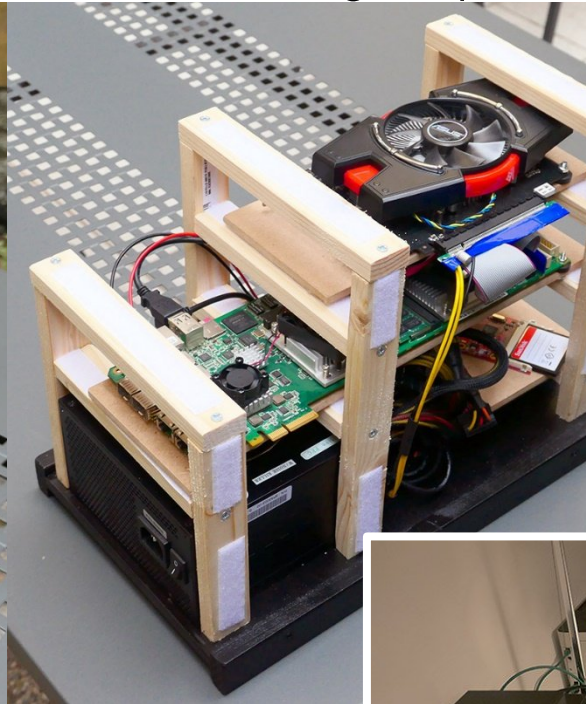
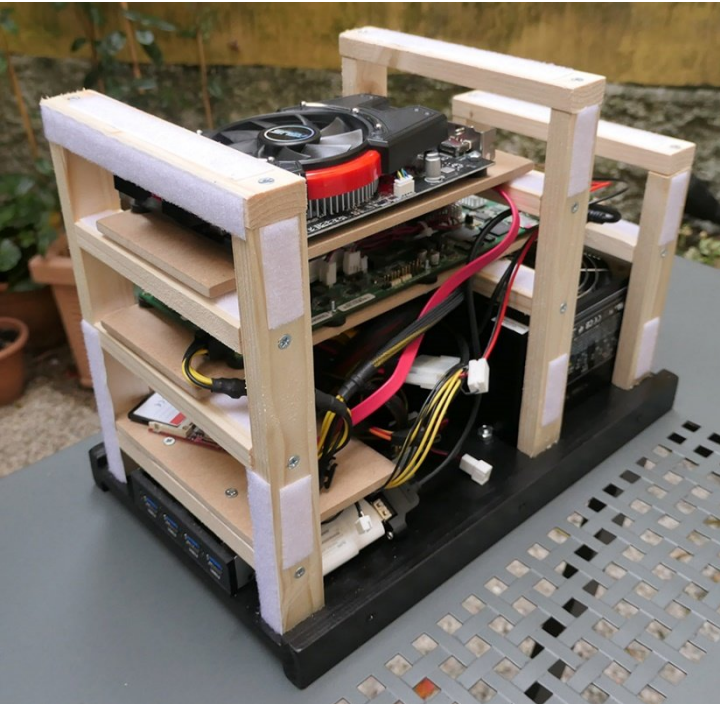

*risultato
finale*



Software

Il software Open Source può essere ri-compilato per PowerPC (PPC).
Noi ci concentriamo solo su port a 64bit (PPC64).

I software più semplici si ri-compilano senza problemi.

I pacchetti più complessi hanno spesso problemi,

Il più delle volte gli sviluppatori non hanno hw PPC (solo x86 & ARM).

I software su cui serve lo sforzo maggiore sono i browser web.

Instancabile lavoro per segnalare bug.

Molti problemi dovuti all'endianess poiché il PPC scelto è big endian.

Stiamo realizzando un repository per PPC64 con Altivec

<http://repo.powerprogress.org/>

Stiamo sistemando alcune distro come Debian, OpenBSD, e Yocto.

Software

Priorità

1. U-Boot bootloader
2. Device Tree (dts, dtb)
3. Kernel per PPC64
4. Distros per PPC64
5. Browsers per PPC64 con Altivec

Timeline

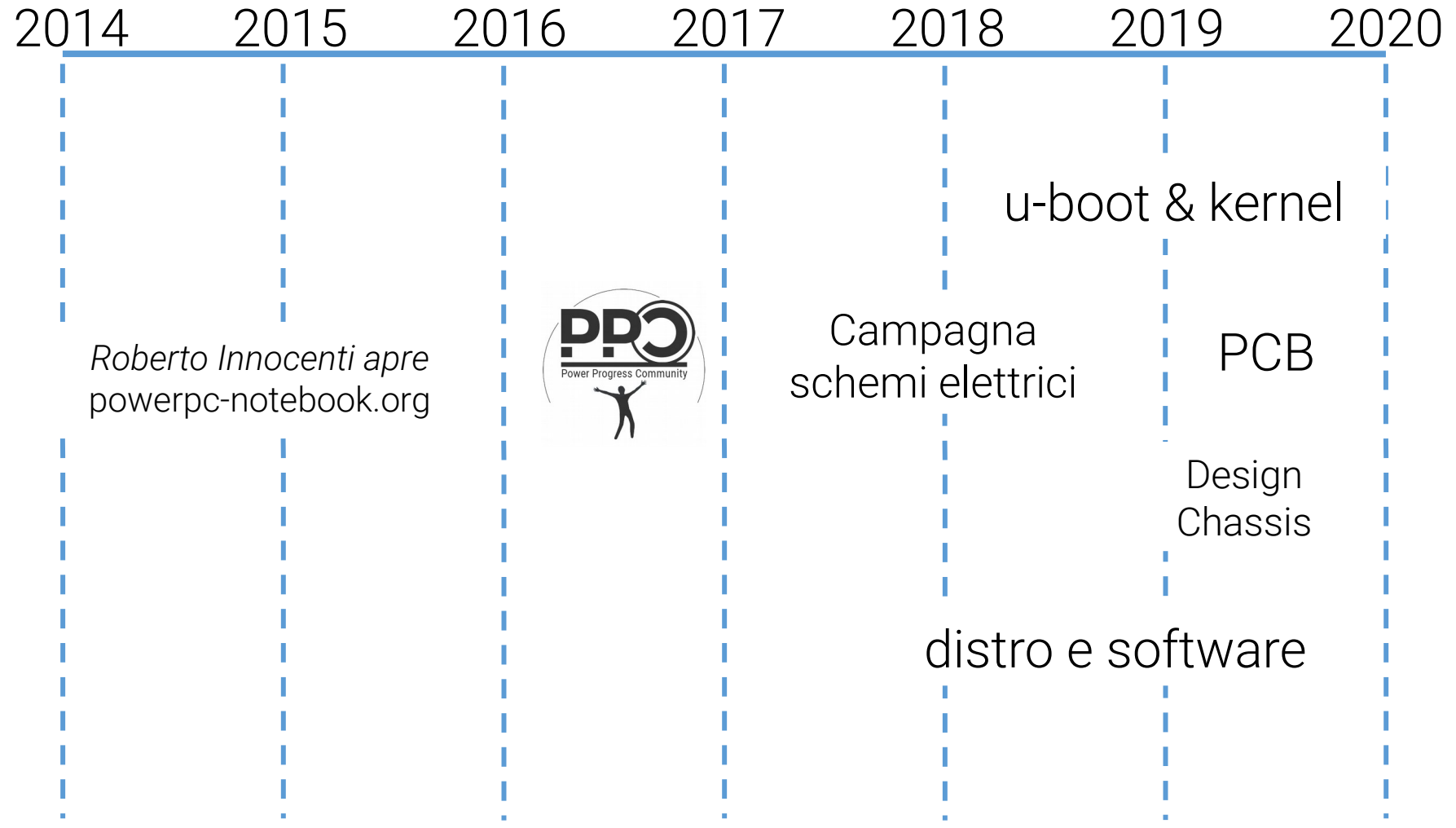



Open Hardware PowerPC Notebook

- Associazione** <http://powerprogress.org/>
- Sito wweb** <http://powerpc-notebook.org/>
- Wiki** <http://wiki.powerpc-notebook.org>
- Forum** <http://forum.powerpc-notebook.org>
- Questionario** <http://survey.powerpc-notebook.org/>
- Newsletter** <http://powerpc-notebook.org/subscribe-powerpc-notebook-newsletter/>
- Facebook** <https://www.facebook.com/powerpcnotebook/>
- Twitter** <https://twitter.com/powerpcnotebook>
- YouTube** cerca "Power Progress Community"